

LITHIUM BATTERIES



Cell size references:CR123A

# CR123A 3.0V 1400mAh

lithium-manganese dioxide batteries

Electrical characteristics

(Stored for one year or less)

◉ Nominal Capacity (5mA to 2.0V, at 25°C)	1400mAh
◉ Nominal voltage	3.0V
◉ Max continuous discharge current	1000mA
◉ Max. Pulse current Current value is obtaining 2.0V cell voltage when pulse is applied for 15 seconds at 50% discharge depth at 25°C	2500mA
◉ Storage temperature	20°C ~ 30°C
◉ Operating temperature	-40°C ~ 60°C
◉ Weight(approx)	17g

WARNING:

Fire, explosion and severe burn hazard. Do not recharge, crush, disassemble, heat above 100°C, incinerate or expose contents to water.

Key features

- High and stable operating voltage
- Low self-discharge rate  
Less than 1% after 1 year of storage at 20°C
- Stainless steel container
- Hermetic glass-to-metal sealing
- Non-flammable electrolyte
- Compliant with IEC 86-4 safety standard
- Non-restricted for transport

UL Component Recognition  
File Number MH 45782

Main applications

- TPMS
- Alarms and security system
- Memory back-up
- Tracking system
- Automotive electronics
- Professional electronics
- Computer real-time clocks

.....

LITHIUM BATTERIES

# CR 123A

lithium-manganese dioxide batteries

Typical discharge at 25°C

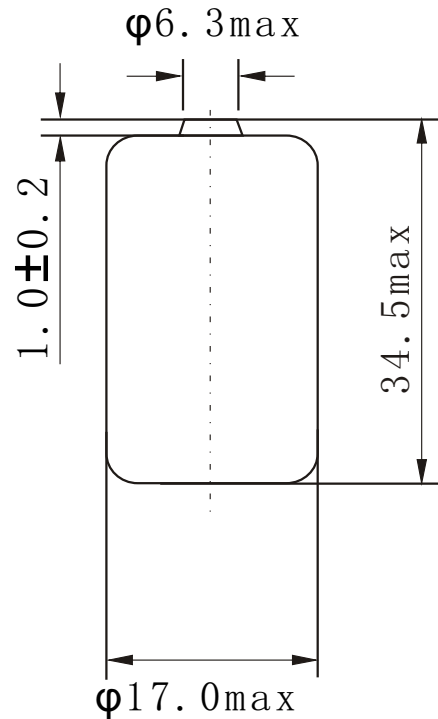
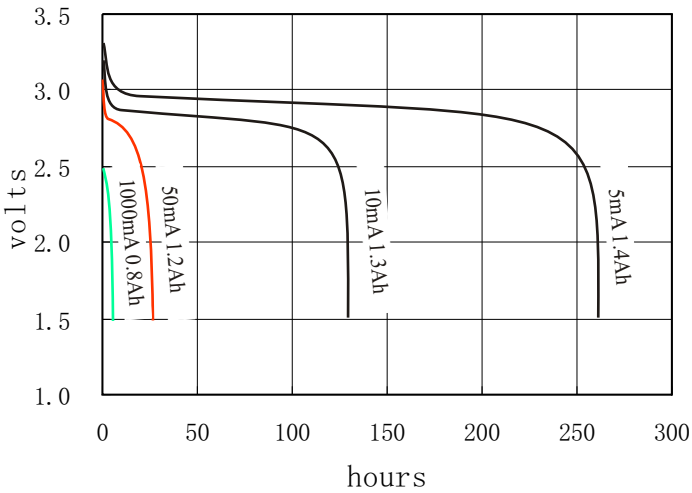

Voltage plateau versus Current and Temperature

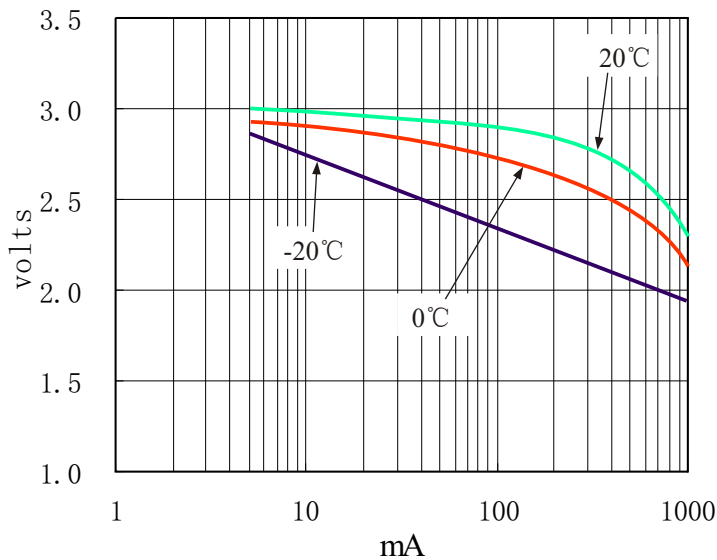

Unit: mm

Available Terminations	
-/P	Axial Pin
-/T /PT2	Radial Pin
-/PT /TP	Polarized Tab