



GUANGZHOU MARKYN BATTERY CO.,LTD

广州基安彼电池有限公司

Communication Backup System

Battery Specification

Type(型号) : GMB-48M10-XXXXXX

Edition(版次): A/0

Document No(文件编号):GMB-Backup-02

Issuing Date(发行日期):2010-08-09

Prepared By 制定	Checked By 审核	Approved By 批准

Add:Block2, Haijing Road6, Markyns Industrial Zone, XinZao Town, Panyu District,
Guangzhou City, P.R.C.

Tel:0086-20-84720852 0086-20-84728502

Fax:0086-20-84720936

PostCode:511436

Website:<http://www.gmbattery.com>

E_mail:info@gmbattery.com



GUANGZHOU MARKYN BATTERY CO., LTD

广州基安彼电池有限公司

GMB-48M10-XXXX BATTERY SPECIFICATIONS
46V/10Ah 通信后备电源动力电池规格书

Edition: A/0

DOCNO:

GMB-Backup-02

DATE: 2010-08-09

1、Battery Pack 电池组

1.1 Basic Parameters 基本参数

1、Cell 组成电芯	Cell Model 电芯型号	LiMn2O4 Cell XXXXXX 锰酸锂电芯	
	Nominal Capacity 标称容量	10.0Ah	
	Nominal Voltage 标称电压	3.7 V	
	Impedance (Max, at 1000Hz) 内阻	≤8.0mΩ	
	Combination Standard 配组标准	A. capacity difference(容差)≤1% B. resistance(内阻)=3~4 mΩ C. current-maintaining ability(荷电保持能力)≥90% D. voltage(0.3C discharging state)电压(0.3C 放电态)=3.0~3.3V	
	Combination Method 组合方式	14pcs 10Ah cells in series (Add PCM and shell)	
2、Pack Battery 成组参数	Nominal Capacity 标称容量 (0.3C ₅ A)	10.0Ah	
	Minimal Capacity 最小容量 (0.3C ₅ A)	9.8Ah	
	Nominal Voltage 标称电压	48.1V	
	Max. Charge Voltage 最大充电电压	54.6V	
	Discharge Cut-off Voltage 放电截止电压	42.0V	
	Charge Current 充电电流	2.0A	
	Max. Working Current 最大工作电流	3.0A	
	Pulse Current 脉冲峰值电流	10.0A 持续 30s	
	Impedance 内阻(Max, at 1000Hz)	≤110mΩ	
	Self-discharge Rate 自放电率	≤3%	
	Cycle Life (80%DOD) 循环寿命	≥2000 次	
	Charge Time 充电时间	Standard 标准充电	0.2C ₅ A×6.5 hrs.
		Quick 快速充电	0.3C ₅ A×2.5 hrs.
	Weight 电池重量 (Approx.)	8.5kg	
Operating Temperature 适用温度	Charge T 充电温度	0℃~45℃;	
	Discharge T 放电温度	-20℃~60℃;	
	Storage 储存温度	-20℃~45℃;	



GUANGZHOU MARKYN BATTERY CO., LTD
 广州基安彼电池有限公司
 GMB-48M10-XXXX BATTERY SPECIFICATIONS
 46V/10Ah 通信后备电源动力电池规格书

Edition: A/0
 DOCNO:
 GMB-Backup-02
 DATE: 2010-08-09

1.2 The Battery Pack Figure 电池组实物图:



1.3 The Working Principle 工作原理图

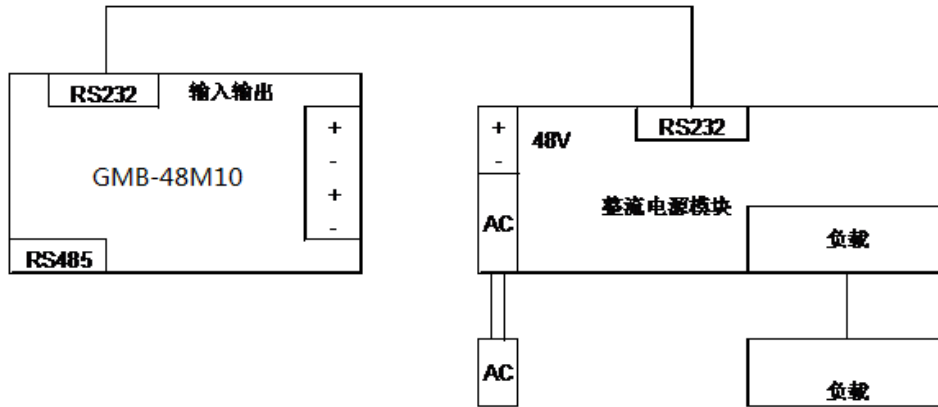

2、PCM Parameters 保护板参数

NO.	Parameters 参数	Standard 标准
1	Over-charge Protection Voltage 过充保护电压	54.6V
2	Over-discharge protection Voltage 过放保护电压	39.0V
3	Maximum continuous working current 最大持续工作电流	3.0A
4	Over current detection current 过流检测电流	5A
5	Short-circuit protection function 短路保护功能	Exist 含有
6	Charge balance function 均衡功能	Exist 含有
7	Automatic recovery after Protection 自恢复功能	Disconnect the charger or the load 移开充电器或负载自恢复
8	Temperature protection (This feature is optional) 温度保护 (可选)	-20~80℃
9	Operating temperature 工作温度	-20~70℃



GUANGZHOU MARKYN BATTERY CO., LTD

广州基安彼电池有限公司

GMB-48M10-XXXX BATTERY SPECIFICATIONS
46V/10Ah 通信后备电源动力电池规格书

Edition: A/0

DOCNO:

GMB-Backup-02

DATE: 2010-08-09

10	Storage temperature 储存温度	-40~80°C
----	-----------------------------	----------

3、Characteristic Curve 特征曲线

3.1 For Single Cell 单只电芯

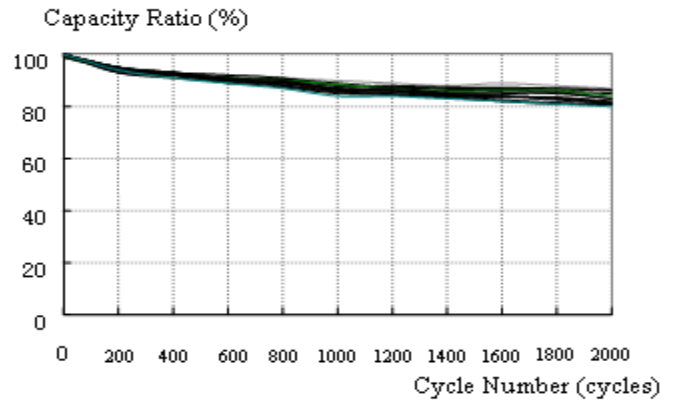
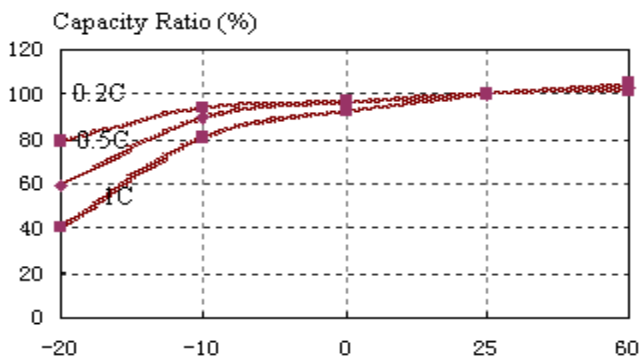
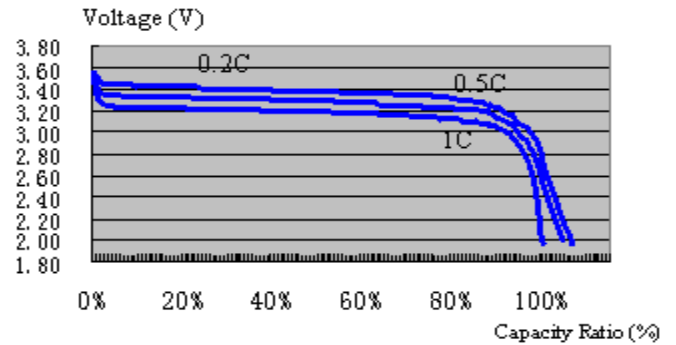
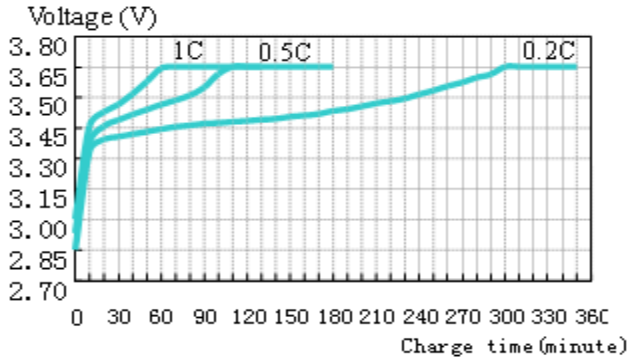

3.2 For Battery Pack 电池组性能曲线

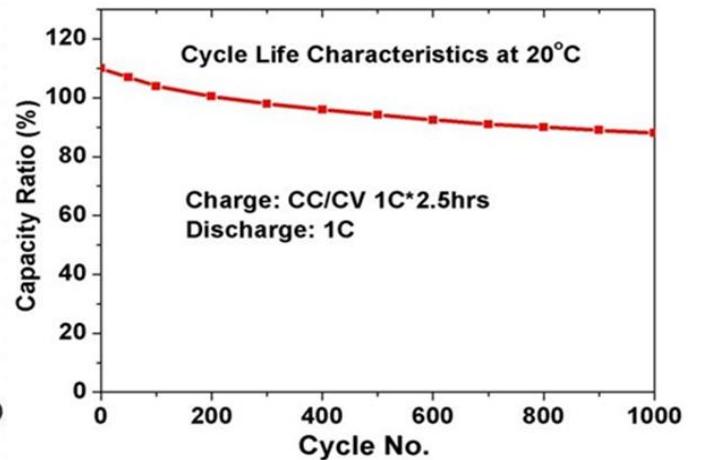
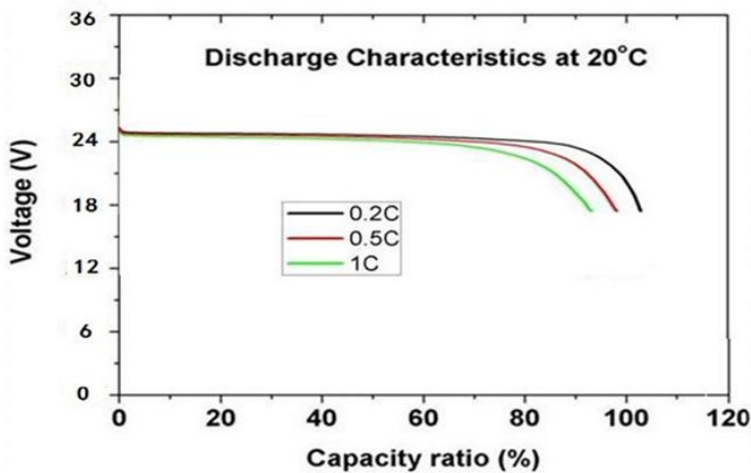

4、Battery Performance 电池性能



GUANGZHOU MARKYN BATTERY CO., LTD

广州基安彼电池有限公司

GMB-48M10-XXXX BATTERY SPECIFICATIONS
46V/10Ah 通信后备电源动力电池规格书

Edition: A/0

DOCNO:

GMB-Backup-02

DATE: 2010-08-09

4.1 Electric Characteristics 电性能

No 序号	Item 项目	Standard 标准	Test method 测试方法
1	Discharge Characteristics 倍率放电性能	0.3C ₅ A ≥100% 1.5C ₅ A ≥90%	<p>a) After standard charged, rest for 30min and then discharge at 0.2C₅A and 1C₅A to the discharge cut-off voltage respectively. Charge/discharge cycle can be conducted for 5 times before meeting the Standards (the same below) . 在 1 标准大气压, 环境温度 20°C±5°C, 相对湿度为 45%~80%的条件下, 电池 0.3C 标准充电后电池在 20°C±5°C下, 以 100I₃(A)电流放电, 直到放电终止电压或企业技术条件中规定的放电终止电压。</p> <p>b) Discharging current and discharging time can be calculated by AH, and expressed by the percentage of nominal capacity.(cycled by 3 times, when one of the tree reaches the standard, it will meet the standard.) 放电电流值和放电时间数据计算容量 (以 Ah 计), 并表达为额定容量的百分数。(以循环三次, 当有一次达到标准, 即达到标准要求)</p>
2	Normal Storage 常温荷电保持能力	Residual capacity 剩余容量 ≥nominal capacity 标称容量 *80% Recovery capacity 恢复容量 ≥nominal capacity 标称容量 *90%	<p>Stored for 28 days after standard charge, discharge at 0.3 C₅A to the discharge cut-off voltage, then test the residual capacity. Teat the recovery capacity, if one of the three cycles can reach the standard, it represents the battery has reached the standard. 电池标准充电后, 开路放置 28 天, 以 0.3C₅A 放电至放电截止电压, 测量蓄电池的剩余容量; 0.3C₅A /0.3C₅A 测量蓄电池的恢复容量, 可循环三次, 当有一次达到标准, 即达到标准要求。</p>
3	Cycle Life 循环寿命	Capacity 容量 ≥nominal Capacity 标称容量*80%	<p>Conduct 0.3C₅A charge/0.3C₅A discharge for 2000 continuous cycles, and then test capacity. 进行 0.3C₅A 充/0.3C₅A 放循环, 2000 次循环后, 测量电池容量</p>
4	Storage Performance 贮存性能	Recovery capacity 恢复容量 ≥nominal capacity 标称容量 *95%	<p>Stored for 1 hour after standard charge, discharge at 0.3C₅A for 2 hours, store the battery for 90 days at 20°C±5°C.store for 1hour after standard charge, then discharge at 0.3C₅A, less than 5 cycles, one of the three cycles reaches the standard means the battery has reached the standard. 电池标准充电后搁置 1h, 以 0.3C₅A 放电 2h, 在 20°C±5°C 储存 90 天; 标准充电后搁置 1h,以 0.3C₅A</p>



GUANGZHOU MARKYN BATTERY CO., LTD

广州基安彼电池有限公司

GMB-48M10-XXXX BATTERY SPECIFICATIONS
46V/10Ah 通信后备电源动力电池规格书

Edition: A/0

DOCNO:

GMB-Backup-02

DATE: 2010-08-09

放电，此充放电最多可循环 5 次，有一次达到要求即可。

4.2 Safety Characteristics 安全性能

No 序号	Item 项目	Standard 标准	Test method 测试方法
1	Overcharge 过充性能	No fire, No explosion 不起火、不爆炸	After standard charge, charge at $3C_5A$ till the voltage of each battery reaches 10.0V, then observe the appearance of the battery. 标准充电后，以 $3C_5A$ 电流充电至每节电池电压 10.0V 结束试验。
2	Over Discharge 过放性能	No fire, No explosion 不起火、不爆炸	Store the battery at $20^{\circ}C \pm 5^{\circ}C$ after standard charge, discharge at $0.3C_5A$ till the voltage reaches 0V. 标准充电后，电池在 $20^{\circ}C \pm 5^{\circ}C$ 下；以 $0.3C_5A$ 电流放电，直至电池电压 0V
3	Short Circuit at Room Temperature 常温短路性能	No fire, No explosion 不爆炸、不起火	Standard charge. Keep the battery into a ventilation cabinet and short-circuit the positive and negative terminals directly (general resistance shall be less than or equal to $5m\Omega$). Stop the test when the temperature falls to $10^{\circ}C$ lower than the peak value. Observe the variation of the battery's appearance. 电池标准充电后，置于防爆玻璃罩中直接短路其正负极（线路总电阻不大于 $5m\Omega$ ）10min，试验结束
4	Hot Oven 热冲击安全性能	No fire, No explosion 不爆炸、不起火	Store the battery for 2 hours at $85 \pm 2^{\circ}C$ cabinet after standard charge. 电池标准充电后，放置于 $85 \pm 2^{\circ}C$ 恒温箱中保持 2h。

4.3 Adaptation to Environment Characteristic 环境适应性能



GUANGZHOU MARKYN BATTERY CO., LTD

广州基安彼电池有限公司

GMB-48M10-XXXX BATTERY SPECIFICATIONS
46V/10Ah 通信后备电源动力电池规格书

Edition: A/0

DOCNO:

GMB-Backup-02

DATE: 2010-08-09

No 序号	Item 项目	Standard 标准	Test method 测试方法
1	Hot cycle Characteristic 热循环性能	No leakage, No smoke, No fire, No explosion 不漏液、不冒烟、不起火、不爆炸。	Store the battery for 48 hours at 75±2°C after standard charge, then store the battery at -20 °C for 6 hours, next store at room temperature for 24hours.Observe the appearance of the battery. 电池标准充电后,在环境温度为 75±2°C 的条件下开路放置 48h, 后在-20 °C 条件下开路放置 6h, 后在室温条件下开路放置 24h。观察电池外观变化。
2	Static Humidity 恒定湿热性能	No obvious outside change, No erosion, No smoke, No explosion, discharging time≥2h. 电池外观无明显变形、无腐蚀、不冒烟、不爆炸, 放电时间≥2h。	Put the battery at 40°C±5°C and 95 % RH chamber for 48h, then get it out and store it for 2h at room temperature. Observe the appearance and discharge at 0.3C ₅ A till the cut-off voltage, then test the final capacity. 电池标准充电后, 置于温度为 40°C±5°C, 相对湿度为 95% 的恒温恒湿箱中, 搁置 48h 后, 取出蓄电池搁置 2h。观察电池外观变化。然后以 0.3C ₅ A 放电至放电截止电压, 测量蓄电池最终容量。
3	Drop Test 跌落性能	No fire ,No explosion 不起火、不爆炸。	Standard charge. Then let it self fall off from a height of 1m (the lowest height) to a smooth hardwood with the thick of 20mm.once for each side. 电池标准充电后, 将电池样品由高度(最低点高度)为 1m 的位置自由跌落到 20mm 厚的硬木板上, 每个面 1 次
4	High and Low Temperature Discharge 不同温度下的放电性能	No appearance change, No leakage, No smoke, No fire, No explosion. 电池外观无明显变形、不漏液, 不冒烟, 不爆炸、不起火。	Standard charge, then store it at 60±2°C for 3 hours, discharge at 0.3C ₅ A to the cut-off voltage, then standard charge at room temperature. 电池标准充电后, 在 60±2°C 条件下恒温搁置 3h、以 0.3C ₅ A 放电至放电截止电压, 然后在室温条件下标准充电。Store it at corresponding temperature according to the 0±2 °C/-10±2 °C order for 20 hours. Test the final capacity at 0.3C ₅ A, at last, store it at room temperature for 2 hours, and test the final state and appearance. 依此按照 0±2 °C/-10±2 °C 的顺序在相应的恒温条件下搁置 20h, 以 0.3C ₅ A 测量蓄电池对应的终止容量, 最后在室温状态下搁置 2h, 测量电池的最终状态观察电池外观变化。



GUANGZHOU MARKYN BATTERY CO., LTD

广州基安彼电池有限公司

GMB-48M10-XXXX BATTERY SPECIFICATIONS
46V/10Ah 通信后备电源动力电池规格书

Edition: A/0

DOCNO:

GMB-Backup-02

DATE: 2010-08-09

5	Vibration 振动环境 适应性能	No obvious outside damage, no leakage, no smoke, no explosion 电池 外观无明显损伤、不漏液、 不冒烟、不爆炸	<p>Standard charge. Equip it to the vibration platform, adjust and prepare the test equipment according to following vibration frequency and relevant swing, doing frequency sweeping from X, Y, Z three directions, each from 10Hz to 55Hz for 30 minutes of recycling, rating of which is 1oct/min:</p> <p>A) vibration frequency:10Hz~30Hz Displacement breadth (single swing): 0.38mm</p> <p>B) vibration frequency: 30Hz~55Hz Displacement breadth (single swing): 0.19mm.Observe the final state after scanning.</p> <p>蓄电池标准充电后, 测量蓄电池初始状态, 安装在振动台面上, 按下面的振动频率和对应的振幅调整好试验设备,X、Y、Z三个方向每个方向上从 10Hz~55Hz 循环扫频振动 30min, 扫频速率为 1oct/min:</p> <p>A)振动频率: 10Hz~30Hz 位移幅值(单振幅): 0.38mm</p> <p>B)振动频率: 30Hz~55Hz 位移幅值(单振幅): 0.19mm。</p> <p>扫频结束后测蓄电池最终状态, 观察电池外观变化</p>
---	---------------------------	---	--

Note: The definitions of some nomenclatures of this specification

- (1) standard charge: 0.3C₅A charge at 20°C±5°C to the limit voltage, then change to charge with constant voltage till the current less than or equal to 0.02C₅A.
- (2) Residual Capacity: The first discharge capacity after being tested by the specific procedure.
- (3) Standard cycle: charge at 0.3C, then rest for 60min, discharge at 0.3C₅A to the cut-off voltage.
- (4) Recovery Capacity: The discharge capacity by implementing charge-discharge cycle repeatedly after being tested by the specific procedure.
- (5) All batteries tested above are within a month unless there are other regulatons.

备注: 以上标准中的一些术语的定义:

- (1) 标准充电: 在环境温度 20°C±5°C 的条件下, 以 0.3C₅A 充电, 当电池端电压达到充电限制电压时, 改为恒压充电, 直到充电电流小于或等于 0.02C₅A 后停止充电
- (2) 剩余容量: 电池经过特定的检测程序后的首次放电容量。
- (3) 标准循环: 电池 0.3C 标准充电后, 搁置 60min, 以 0.3C₅A 放电至放电截止电压。
- (4) 恢复容量: 电池经过特定的检测程序后, 通过反复充放电使状态恢复后的放电容量。
- (5) 用于上述测试的电池必须是交货一个月内的电池, 除非另有规定。

5、 Standard Environmental Test Condition 标准测试环境

Unless otherwise specified, all tests stated in this Product Specification are conducted at below condition:

除非特别说明, 本规格书中所有测试均在以下环境条件下进行:

Temperature: 20±5°C

温度: 20±5°C

Humidity: 25-85% RH

湿度: 25-85% RH

Air pressure: 86KPa~106 kPa

	GUANGZHOU MARKYN BATTERY CO., LTD 广州基安彼电池有限公司	Edition: A/0 DOCNO:
	GMB-48M10-XXXX BATTERY SPECIFICATIONS 46V/10Ah 通信后备电源动力电池规格书	GMB-Backup-02 DATE: 2010-08-09

大气压: 86KPa~106 kPa

6、Battery Use 电池使用

- (1) Before using it, you should read the battery and charger specification carefully to prevent the risk caused by damaged battery and charger.

在使用电池前, 先仔细阅读电池规格书及充电器规书, 以防止损坏电池和充电器而导致危险。

- (2) When you combine the battery with series or parallels, if there are oxidation layer on the surface, you should brush surface to the metal glow with thin steel brush to lower the connective resistance to the minimal resistance.

电池进行串联或是并联时, 如联接端子表面有氧化层, 一定先用细丝钢刷或其它类似工具将电池正负极端子刷至出现金属光泽, 以将连接电阻降至最低;

- (3) When combining with many batteries, if the voltage between the two electrodes is over 36V, the safe voltage for human beings, to guarantee the safety, you should not touch the two electrodes with your body.

在将此电池进行多只串联时, 如果组成的最终电池组两端电压超过人体安全电压 36V 时, 为保证人身安全, 此时禁止用身体直接接触电池组正负端。

(4) 电池在出厂前已经进行配组, 所以在使用中不可对单体或部分单体电池进行充放电, 这样会造成电池组各单体间的性能失调, 影响整组的性能;

(5) 电池在使用时需配套铁锂电池保护或管理系统, 即对电池组中每一只电池的过压、欠压、过流、过温等充放电参数进行控制, 否则会造成电池的损坏。

7、Charge 电池充电

When charging the battery group, please use the chargers consistent with the type of battery. The output of the charger must meet the parameter requirement of the battery group.

对电池组进行充电时, 请使用为此型号电池组配备的专用充电器。充电器输出需符合此电池组充电参数要求。

8、Storage and Others 储存及其它事项

- (1) long time storage 长期储存

If the cell is stored for a long time(exceed three months), the cell should be stored in drying and cooling place. The cell should be charged and discharged each six months. The cell's storage voltage should be 3.2~3.35V and the cell is to be stored in a condition as NO.5.

长期储存的电池(超过 3 个月)须置于干燥、凉爽处。每 6 个月对电池进行一次充放电, 储存电压为 3.2~3.35V(电池组中串联的每节电池)且储存环境要求如上述第 5 项。

- (2) others 其它事项

Any matters that this specification does not cover should be covered between the customer and GMB.

本规格书中未提及的事项, 须经双方协商确定。

9、Warranty Period& Product Liability 保质期及产品责任

- ◆ Warranty period begins from the delivery date, and is exclusively made in the sale contract.

保质期是从出厂日期(喷码/标示)开始起, 质保期在销售合同中另定;

- ◆ GMB is not responsible for the incident caused by not obeying the specifications.

广州基安彼电池有限公司对因没有按本规格书规定操作而导致的意外不负责任;

- ◆ When the specification is modified, GMB does not inform the customer.

当本规格书版本更新时, 广州基安彼电池有限公司不做另行通知。

	GUANGZHOU MARKYN BATTERY CO., LTD 广州基安彼电池有限公司	Edition: A/0 DOCNO:
	GMB-48M10-XXXX BATTERY SPECIFICATIONS 46V/10Ah 通信后备电源动力电池规格书	GMB-Backup-02 DATE: 2010-08-09

10、 Signs on the Battery Package 包装电池上的标识

All the cautions should be written on the packed battery. 以下警告应注明在包装后的电池上

- Before using the battery, you should read the specifications of battery and charger carefully.
使用电池前，先仔细阅读电池规格书及充电器规格书
- When the voltage between two electrodes is beyond 36V, human's safe voltage, you should not touch the two electrodes with your body.
当电池组两端电压超过人体安全电压 36V 时，禁止用身体直接接触电池组正负端。
- Use specified charger
使用规定的充电器
- Do not throw the battery into fire or heat it.
不要将电池投入火中或加热
- Do not short-circuit the two electrodes.
不要将电池正负极两端短路
- Do not disassemble and break up the battery.
不要将电池分解拆散

11、 Cautions in Using Battery. 电池使用时警告事项及注意事项

Caution

警告！

- When the voltage between the two electrodes is over 36V, the safe voltage of human beings, you should not touch them with your body.
当电池组两端电压超过人体安全电压 36V 时，禁止用身体直接接触电池组正负端。
- Do not immerse the battery in water or seawater, and keep the battery in a cool dry surrounding if it stands by.
严禁将电池浸入海水或水中,保存不用时,应放置于阴凉干燥的环境中。
- Does not use or leave the battery near a heat source as fire or heater
禁止将电池在热高温源旁,如火、加热器等使用和留置。
- Use the battery charger specifically for that purpose when recharging.
充电时请使用为此型号电池组配备的专用充电器。
- Do not reverse the position and negative terminals.
严禁颠倒正负极使用电池。
- Do not connect the battery electrodes to an electrical outlet.
严禁将电池正负端直接插入电源插座。
- Do not discard the battery in fire or a heater.
禁止将电池丢于火或加热器中。
- Do not short-circuit the battery by directly connecting the positive and negative terminals with metal objects.
禁止用金属直接连接电池正负极短路。
- Do not transport or store the battery together with metal objects such as hairpins, necklaces, etc.
禁止将电池与金属,如发夹、项链等一起运输或贮存。

	GUANGZHOU MARKYN BATTERY CO., LTD 广州基安彼电池有限公司	Edition: A/0 DOCNO:
	GMB-48M10-XXXX BATTERY SPECIFICATIONS 46V/10Ah 通信后备电源动力电池规格书	GMB-Backup-02 DATE: 2010-08-09

- Do not strike, trample or throw the battery.
禁止敲击或抛掷、踩踏电池等.
- Do not directly solder the battery and pierce the battery with a nail or other sharp objects.
禁止直接焊接电池和用钉子或其它利器刺穿电池.

Special cautions

特别警告!

Due to the voltage between two electrodes over the safe voltage of human beings, nobody should touch the two electrodes by his body in case of his safety. During using the battery, you need insulate the two electrode terminals and also the part outside the metal conductor, in order to prevent the short-circuit incident. You should do the related safety-prevention work well. 池组两端电压已超过人体安全电压,为安全起见,禁此用身体同时接触电池组正负极两端,在电池组使用过程中,需将电池组正负极两端及金属导体外露部分做好绝缘处理,防止任何有可能发生短路的情况出现,且做好安全防范的相关工作。

Be Careful. 小 心 !

- Do not use or leave the battery at high temperature (for example, at strong direct sunlight or in a vehicle in extremely hot weather). Otherwise, it can overheat or fire or its performance will be degenerate and its service life will be decreased
禁止在高温下(炙热的阳光下或很热的汽车中)使用或放置电池,否则可能会引起电池过热、起火或功能失效、寿命减短.
- Do not use the battery in a location where static electricity and magnetic field is great, otherwise, the safety devices may be damaged, causing hidden trouble of safety.
禁止在强静电和强磁场的地方使用,否则易破坏电池安全保护装置,带来不安全的隐患.
- If the battery leaks and the electrolyte gets into the eyes, do not rub the eyes, instead, rinse the eyes with clean water, and immediately seek medical attention. Otherwise, it may injure eyes.
如果电池发生泄露,电解液进入眼睛,请不要揉擦,应用清水冲洗眼睛,并立即送医治疗,否则会伤害眼睛.
- If the battery gives off strange odor, generates heat, becomes discolored or deformed, or in any way appear abnormal during use, recharging or storage, immediately remove it from the device or battery charger and stop using it.
如果电池发出异味,发热、变色、变形或使用、贮存、充电过程中出现任何异常,立即将电池从装置或充电器中移离并停用.
- In case the battery terminals are dirty, clean the terminals with a dry cloth before use. Otherwise poor performance may occur due to the poor connection with the instrument.
如果电极弄脏,使用前应用干布抹净,否则可能会导致接触不良功能失效
- Be aware discarded batteries may cause fire or explosion; tape the battery terminals to insulate them
废弃之电池应用绝缘纸包住电极,以防起火、爆炸。

12、 Free-responsibility declaration 免责声明

Before using the battery, you should read the specifications, usage instruction and some attentions carefully to learn its application method and areas. If the phenomenon such as error using method or wrong circuit connection, or input power data, working index are inconsistent with the specifications happen and cause damage to production, circuit and its accessories, we are not responsible for it.



GUANGZHOU MARKYN BATTERY CO., LTD

广州基安彼电池有限公司

GMB-48M10-XXXX BATTERY SPECIFICATIONS
46V/10Ah 通信后备电源动力电池规格书

Edition: A/0

DOCNO:

GMB-Backup-02

DATE: 2010-08-09

产品使用前，请用户仔细阅读产品规格书、使用说明书及使用注意事项等，了解产品的使用方法及应用范围；若出现产品使用方法错误、电路连接不对或采用的输入电源、负载功能参数与产品规格书所标性能参数不符等现象均属使用不当，由使用不当造成产品、负载及周边连接件的损坏，本公司均不承担任何责任。

Any matters this specification does not cover should be covered by GMB the customer.

本规格书中任何未提及的事项，须经双方协商确定；

The final explanation right belongs to Guangzhou Markyn batteryCo., Ltd.

本规格书的最终解释权归广州基安彼电池有限公司。